

gebog316

FITTINGS, GEWINDENIPPEL, KUGELHÄHNE
UND SCHMUTZFÄNGER AUS EDELSTAHL





EDELSTAHL-GEWINDEFITTINGS

S. 3

- Alle gegossenen Artikel sind gefertigt aus Material 1.4408
Legierungsbestandteile in %: C ≤ 0,07 · Cr 18,0 – 20,0 · Ni 9,0 – 12,0 · Mo 2,0 – 2,5
Bogen Art.-Nr. 6003 und Muffen Art.-Nr. 6270 und 6272 sind gefertigt aus Material 1.4404 (AISI 316L)
- Alle flachdichtenden Verschraubungen sind mit einer Dichtung aus PTFE ausgestattet (nicht für Trinkwasser geeignet)
- Alle Artikel sind gekennzeichnet mit Druckstufe 150 lbs ~ 10,5 bar.
- Die Materialien 1.4408 + 1.4404 sind einsetzbar für die Medien Wasser, Trinkwasser, verschiedene chemische Substanzen
- Gute Korrosionsbeständigkeit und Säurebeständigkeit
- Maximale Betriebstemperatur für Gewindefittings (ohne weitere mechanische Einwirkung von Kräften): 220 °C. Maximale Betriebstemperatur für flachdichtende Verschraubungen: 95°C.
- Anschlussgewinde gemäß DIN EN 10226-1 (ISO 7/1)



KUGELHÄHNE

S. 19

- Alle Grundkörper sind aus dem Material CF8M gefertigt, die Materialien der Einzelteile sind in den Werkstofflisten ab Seite 231 aufgeführt
- Alle Kugelhähne sind mit Dichtungen aus PTFE ausgestattet
- Alle Kugelhähne sind mit der max. zulässigen Druckstufe PN63 gekennzeichnet
- Die Druckstufen und Temperaturverläufe sind den Tabellen ab Seite 229 zu entnehmen
- Einsetzbar für die Medien Wasser und verschiedene chemische Substanzen
- Gute Säure- und Korrosionsbeständigkeit
- Alle Kugelhähne sind mit einer abschließbaren Schließlasche ausgestattet
- Die Gewindeanschlüsse entsprechen der DIN EN 10226-1 (ISO 7/1)



SCHMUTZFÄNGER AUS EDELSTAHL

S. 24

- Schmutzfänger mit Innengewinde DIN EN 10226-1 / ISO 7-1
- Siebeinsatz mit Dichtung als Ersatzteil erhältlich



ROHRGEWINDENIPPEL

S. 25

- Rohrdoppelnippel und Nippel mit Anschweißenden sind aus geschweißten Edelstahlrohren (Material 1.4404) nach DIN EN 10255 (Maße), DIN EN 10241 (Längen)
- Einsetzbar für die Medien Wasser, Trinkwasser und verschiedene chemische Substanzen
- Druckstufen: max. 50 bar [20 °C]
- Die Gewinde entsprechen der DIN EN 10226-1 (ISO 7/1)

3		LANGER BOGEN 90°, A/A		MAT. 1.4404			
GRÖSSE	ARTIKEL-NR.	ABMESSUNGEN [MM]					
		L					
1/4"	6003-014	60,0					
3/8"	6003-038	70,0					
1/2"	6003-012	80,0					
3/4"	6003-034	100,0					
1"	6003-100	120,0					
1 1/4"	6003-114	140,0					
1 1/2"	6003-112	160,0					
2"	6003-200	190,0					

90		WINKEL 90°, I/I, BEIDE SEITEN GLEICH		MAT. 1.4408			
GRÖSSE	ARTIKEL-NR.	ABMESSUNGEN [MM]					
		L	D1				
1/8"	6090-018	17,0	13,0				
1/4"	6090-014	19,0	16,0				
3/8"	6090-038	23,0	20,0				
1/2"	6090-012	27,0	24,5				
3/4"	6090-034	32,0	30,0				
1"	6090-100	38,0	37,5				
1 1/4"	6090-114	45,0	46,5				
1 1/2"	6090-112	48,0	53,0				
2"	6090-200	57,0	65,5				
2 1/2"	6090-212	69,0	82,0				
3"	6090-300	78,0	95,5				
4"	6090-400	96,0	121,5				

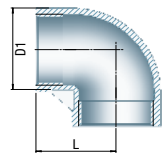
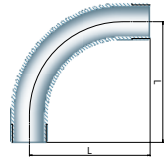

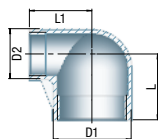

90		WINKEL 90°, I/I, REDUZIERT				MAT. 1.4408	
GRÖSSE [1 X 2]	ARTIKEL-NR.	ABMESSUNGEN [MM]					
		L	L1	D1	D2		
1/2" x 3/8"	6090-012038	25,0	26,0	24,5	20,0		
3/4" x 3/8"	6090-034038	28,0	28,0	30,0	20,0		
3/4" x 1/2"	6090-034012	30,0	29,0	30,0	24,5		
1" x 1/2"	6090-100012	33,0	32,0	37,5	24,5		
1" x 3/4"	6090-100034	35,0	34,0	37,5	30,0		
1 1/4" x 3/4"	6090-114034	40,0	38,0	46,5	30,0		
1 1/4" x 1"	6090-114100	42,0	40,0	46,5	37,5		
1 1/2" x 1"	6090-112100	45,0	41,0	53,0	37,5		
1 1/2" x 1 1/4"	6090-112114	48,0	45,0	53,0	46,5		
2" x 1 1/4"	6090-200114	54,0	48,0	65,5	46,5		
2" x 1 1/2"	6090-200112	55,0	52,0	65,5	53,0		

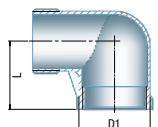

92		WINKEL 90°, A/I, BEIDE SEITEN GLEICH				MAT. 1.4408	
GRÖSSE	ARTIKEL-NR.	ABMESSUNGEN [MM]					
		L	D1				
1/8"	6092-018	17,0	13,0				
1/4"	6092-014	19,0	16,0				
3/8"	6092-038	23,0	20,0				
1/2"	6092-012	27,0	24,5				
3/4"	6092-034	32,0	30,0				
1"	6092-100	38,0	37,5				
1 1/4"	6092-114	45,0	46,5				
1 1/2"	6092-112	48,0	53,0				
2"	6092-200	57,0	65,5				
2 1/2"	6092-212	69,0	82,0				
3"	6092-300	78,0	95,5				
4"	6092-400	97,0	121,5				

95		WINKELVERSCHRAUBUNG 90°, FLACH DICHTEND, I/I					MAT. 1.4408
GRÖSSE	ARTIKEL-NR.	ABMESSUNGEN [MM]					
		L	L1	D1	H	SW	
1/4"	6095-014	46,5	13,5	16,0	17,0	27	
3/8"	6095-038	51,0	15,0	19,0	20,0	30	
1/2"	6095-012	56,0	16,0	26,0	27,0	36	
3/4"	6095-034	61,0	17,0	31,5	31,0	43	
1"	6095-100	70,5	20,0	39,0	36,0	51	
1 1/4"	6095-114	78,0	22,0	47,5	42,0	61	
1 1/2"	6095-112	83,0	24,0	54,0	46,0	69	
2"	6095-200	96,0	27,0	66,5	56,0	83	

96		WINKELVERSCHRAUBUNG 90°, KONISCH DICHTEND, I/I					MAT. 1.4408
GRÖSSE	ARTIKEL-NR.	ABMESSUNGEN [MM]					
		L	L1	D1	H	SW	
1/4"	6096-014	46,5	13,5	16,0	17,0	27	
3/8"	6096-038	51,0	15,0	19,0	20,0	30	
1/2"	6096-012	56,0	16,0	26,0	27,0	36	
3/4"	6096-034	61,0	17,0	31,5	31,0	43	
1"	6096-100	70,5	20,0	39,0	36,0	51	
1 1/4"	6096-114	78,0	22,0	47,5	42,0	61	
1 1/2"	6096-112	83,0	24,0	54,0	46,0	69	
2"	6096-200	96,0	27,0	66,5	56,0	83	

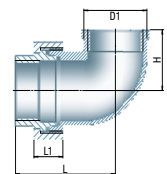
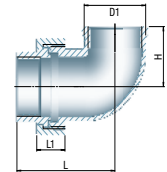

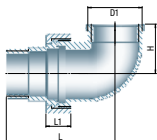

97		WINKELVERSCHRAUBUNG 90°, FLACH DICHTEND, A/I					MAT. 1.4408
GRÖSSE	ARTIKEL-NR.	ABMESSUNGEN [MM]					
		L	L1	D1	H	SW	
1/4"	6097-014	57,0	13,5	16,0	17,0	27	
3/8"	6097-038	62,0	15,0	19,0	20,0	30	
1/2"	6097-012	70,5	16,0	26,0	27,0	36	
3/4"	6097-034	76,5	17,0	31,5	31,0	43	
1"	6097-100	88,5	20,0	39,0	36,0	51	
1 1/4"	6097-114	100,0	22,0	47,5	42,0	61	
1 1/2"	6097-112	103,5	24,0	54,0	46,0	69	
2"	6097-200	121,0	27,0	66,5	56,0	83	

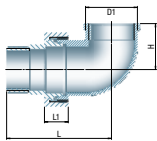

98		WINKELVERSCHRAUBUNG 90°, KONISCH DICHTEND, A/I					MAT. 1.4408
GRÖSSE	ARTIKEL-NR.	ABMESSUNGEN [MM]					
		L	L1	D1	H	SW	
1/4"	6098-014	57,0	13,5	16,0	17,0	27	
3/8"	6098-038	62,0	15,0	19,0	20,0	30	
1/2"	6098-012	70,5	16,0	26,0	27,0	36	
3/4"	6098-034	76,5	17,0	31,5	31,0	43	
1"	6098-100	88,5	20,0	39,0	36,0	51	
1 1/4"	6098-114	100,0	22,0	47,5	42,0	61	
1 1/2"	6098-112	103,5	24,0	54,0	46,0	69	
2"	6098-200	121,0	27,0	66,5	56,0	83	

120		WINKEL 45°, I/I		MAT. 1.4408			
GRÖSSE	ARTIKEL-NR.	ABMESSUNGEN [MM]					
		L	D1				
1/8"	6120-018	16,0	13,0				
1/4"	6120-014	17,0	16,0				
3/8"	6120-038	19,0	20,0				
1/2"	6120-012	21,0	24,5				
3/4"	6120-034	25,0	30,0				
1"	6120-100	29,0	37,5				
1 1/4"	6120-114	33,0	46,5				
1 1/2"	6120-112	37,0	53,0				
2"	6120-200	42,0	65,5				

121		WINKEL 45°, A/I		MAT. 1.4408			
GRÖSSE	ARTIKEL-NR.	ABMESSUNGEN [MM]					
		L	D1				
1/4"	6121-014	19,0	16,0				
3/8"	6121-038	23,0	20,0				
1/2"	6121-012	27,0	24,5				
3/4"	6121-034	32,0	30,0				
1"	6121-100	38,0	37,5				
1 1/4"	6121-114	45,0	46,5				
1 1/2"	6121-112	48,0	53,0				
2"	6121-200	57,0	65,5				

130		T-STÜCK 90°, I/I/I, 3 SEITEN GLEICH		MAT. 1.4408			
GRÖSSE	ARTIKEL-NR.	ABMESSUNGEN [MM]					
		L	D1				
1/8"	6130-018	17,0	13,0				
1/4"	6130-014	19,0	16,5				
3/8"	6130-038	23,0	20,0				
1/2"	6130-012	27,0	24,5				
3/4"	6130-034	32,0	30,0				
1"	6130-100	38,0	37,5				
1 1/4"	6130-114	45,0	46,5				
1 1/2"	6130-112	48,0	53,0				
2"	6130-200	57,0	65,5				
2 1/2"	6130-212	69,0	82,0				
3"	6130-300	78,0	95,5				

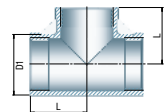
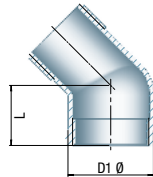
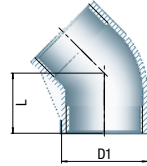

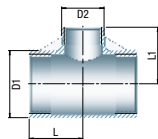

130	T-STÜCK 90° I/I/I, REDUZIERT	MAT. 1.4408				
GRÖSSE [1X2]	ARTIKEL-NR.	ABMESSUNGEN [MM]				
		L	L1	D1	D2	
1/4" x 1/8"	6130-014018	18,0	18,0	16,0	13,0	
3/8" x 1/4"	6130-038014	20,0	22,0	20,0	16,0	
1/2" x 1/4"	6130-012014	24,0	24,0	24,5	16,0	
1/2" x 3/8"	6130-012038	26,0	25,0	24,5	20,0	
3/4" x 3/8"	6130-034038	28,0	28,0	30,0	20,0	
3/4" x 1/2"	6130-034012	29,0	30,0	30,0	24,5	
1" x 1/2"	6130-100012	32,0	33,0	37,5	24,5	
1" x 3/4"	6130-100034	34,0	35,0	37,5	30,0	
1 1/4" x 3/4"	6130-114034	38,0	40,0	46,5	30,0	
1 1/4" x 1"	6130-114100	40,0	42,0	46,5	37,5	
1 1/2" x 3/4"	6130-112034	37,0	43,0	53,0	30,0	
1 1/2" x 1"	6130-112100	41,0	45,0	53,0	37,5	
1 1/2" x 1 1/4"	6130-112114	45,0	48,0	53,0	46,5	
2" x 1"	6130-200100	44,0	51,0	65,5	37,5	
2" x 1 1/4"	6130-200114	48,0	54,0	65,5	46,5	
2" x 1 1/2"	6130-200112	52,0	55,0	65,5	53,0	

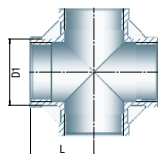

180	KREUZSTÜCK, I/I/I/I, 4 SEITEN GLEICH	MAT. 1.4408				
GRÖSSE	ARTIKEL-NR.	ABMESSUNGEN [MM]				
		L	D1			
1/8"	6180-018	17,0	13,0			
1/4"	6180-014	19,0	16,0			
3/8"	6180-038	23,0	20,0			
1/2"	6180-012	27,0	24,5			
3/4"	6180-034	32,0	30,0			
1"	6180-100	38,0	37,5			
1 1/4"	6180-114	45,0	46,5			
1 1/2"	6180-112	48,0	53,0			
2"	6180-200	57,0	65,5			

220	Y-VERTEILER, 1/1/1	MAT. 1.4408				
GRÖSSE	ARTIKEL-NR.	ABMESSUNGEN [MM]				
		L	D1			
1/4"	6220-014	19,0	18,0			
3/8"	6220-038	23,0	21,5			
1/2"	6220-012	27,0	26,5			
3/4"	6220-034	32,0	32,0			
1"	6220-100	40,9	43,2			
1 1/4"	6220-114	45,0	49,0			
1 1/2"	6220-112	48,0	55,5			
2"	6220-200	57,0	68,5			



240	REDUZIERMUFFE, 1/1	MAT. 1.4408				
GRÖSSE [1 X 2]	ARTIKEL-NR.	ABMESSUNGEN [MM]				
		L	D1	D2		
1/4" x 1/8"	6240-014018	25,0	17,5	14,0		
3/8" x 1/8"	6240-038018	23,0	21,0	14,0		
3/8" x 1/4"	6240-038014	26,0	21,0	17,5		
1/2" x 1/8"	6240-012018	34,0	26,5	14,0		
1/2" x 1/4"	6240-012014	34,0	26,5	17,5		
1/2" x 3/8"	6240-012038	34,0	26,5	21,0		
3/4" x 1/8"	6240-034018	36,0	32,0	14,0		
3/4" x 1/4"	6240-034014	36,0	32,0	17,5		
3/4" x 3/8"	6240-034038	36,0	32,0	21,0		
3/4" x 1/2"	6240-034012	36,0	32,0	25,5		
1" x 3/8"	6240-100038	42,0	39,0	21,0		
1" x 1/2"	6240-100012	42,0	39,0	25,5		
1" x 3/4"	6240-100034	42,0	39,0	31,0		
1 1/4" x 1/2"	6240-114012	48,0	48,0	25,5		
1 1/4" x 3/4"	6240-114034	48,0	48,0	31,0		
1 1/4" x 1"	6240-114100	48,0	48,0	39,0		
1 1/2" x 1/2"	6240-112012	52,0	54,0	25,5		
1 1/2" x 3/4"	6240-112034	52,0	54,0	31,0		
1 1/2" x 1"	6240-112100	52,0	54,0	39,0		
1 1/2" x 1 1/4"	6240-112114	52,0	54,0	48,0		
2" x 1/2"	6240-200012	58,0	67,5	25,5		
2" x 3/4"	6240-200034	58,0	67,5	31,0		
2" x 1"	6240-200100	58,0	67,5	39,0		
2" x 1 1/4"	6240-200114	58,0	67,5	48,0		
2" x 1 1/2"	6240-200112	58,0	67,5	54,0		
2 1/2" x 1 1/2"	6240-212112	65,0	84,0	54,0		
2 1/2" x 2"	6240-212200	65,0	84,0	67,5		
3" x 2"	6240-300200	72,0	98,0	67,5		
3" x 2 1/2"	6240-300212	72,0	98,0	84,0		
4" x 2"	6240-400200	94,0	125,0	67,5		
4" x 2 1/2"	6240-400212	94,0	125,0	84,0		
4" x 3"	6240-400300	94,0	125,0	98,0		





241	REDUZIERNIPPLE, A/I	MAT. 1.4408			
GRÖSSE [1X2]	ARTIKEL-NR.	ABMESSUNGEN [MM]			
		L	SW		
1/4" x 1/8"	6241-014018	16,0	14,0		
3/8" x 1/8"	6241-038018	16,5	18,0		
3/8" x 1/4"	6241-038014	16,5	18,0		
1/2" x 1/8"	6241-012018	20,0	22,0		
1/2" x 1/4"	6241-012014	20,0	22,0		
1/2" x 3/8"	6241-012038	20,0	22,0		
3/4" x 1/8"	6241-034018	21,0	27,5		
3/4" x 1/4"	6241-034014	21,0	27,5		
3/4" x 3/8"	6241-034038	21,0	27,5		
3/4" x 1/2"	6241-034012	21,0	27,5		
1" x 1/4"	6241-100014	24,5	34,5		
1" x 3/8"	6241-100038	24,5	34,5		
1" x 1/2"	6241-100012	24,5	34,5		
1" x 3/4"	6241-100034	24,5	34,5		
1 1/4" x 3/8"	6241-114038	27,5	43,0		
1 1/4" x 1/2"	6241-114012	27,5	43,0		
1 1/4" x 3/4"	6241-114034	27,5	43,0		
1 1/4" x 1"	6241-114100	27,5	43,0		
1 1/2" x 3/8"	6241-112038	28,5	49,0		
1 1/2" x 1/2"	6241-112012	28,5	49,0		
1 1/2" x 3/4"	6241-112034	28,5	49,0		
1 1/2" x 1"	6241-112100	28,5	49,0		
1 1/2" x 1 1/4"	6241-112114	28,5	49,0		
2" x 1/2"	6241-200012	33,0	61,0		
2" x 3/4"	6241-200034	33,0	61,0		
2" x 1"	6241-200100	33,0	61,0		
2" x 1 1/4"	6241-200114	33,0	61,0		
2" x 1 1/2"	6241-200112	33,0	61,0		
2 1/2" x 1"	6241-212100	37,0	76,0		
2 1/2" x 1 1/4"	6241-212114	37,0	76,0		
2 1/2" x 1 1/2"	6241-212112	37,0	76,0		
2 1/2" x 2"	6241-212200	37,0	76,0		
3" x 1 1/4"	6241-300114	40,0	90,0		
3" x 1 1/2"	6241-300112	40,0	90,0		
3" x 2"	6241-300200	40,0	90,0		
3" x 2 1/2"	6241-300212	40,0	90,0		
4" x 2"	6241-400200	46,0	115,0		
4" x 2 1/2"	6241-400212	46,0	115,0		
4" x 3"	6241-400300	46,0	115,0		

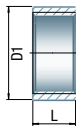

272		HALBE MUFFE, I/I, BEIDE SEITEN GLEICH			MAT. 1.4404		
GRÖSSE	ARTIKEL-NR.	ABMESSUNGEN [MM]					
		L	D1				
1/8"	6272-018	10,0	14,0				
1/4"	6272-014	11,0	18,5				
3/8"	6272-038	12,0	21,3				
1/2"	6272-012	15,0	26,4				
3/4"	6272-034	17,0	31,8				
1"	6272-100	19,5	39,5				
1 1/4"	6272-114	22,0	48,3				
1 1/2"	6272-112	22,0	54,5				
2"	6272-200	26,0	66,3				
2 1/2"	6272-212	30,5	82,0				
3"	6272-300	34,0	95,0				
4"	6272-400	39,0	122,0				

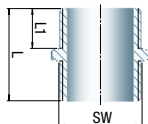

Art.-Nr. mit * in Ausführung Zehnkant

280		SECHSKANT-DOPPELNIPPEL, A/A			MAT. 1.4408		
GRÖSSE	ARTIKEL-NR.	ABMESSUNGEN [MM]					
		L	L1	SW			
1/8"	6280-018	20,0	8,0	11,0			
1/4"	6280-014	25,0	10,5	15,0			
3/8"	6280-038	27,0	11,0	18,0			
1/2"	6280-012	34,0	14,5	22,0			
3/4"	6280-034	36,5	15,5	28,0			
1"	6280-100	42,0	18,0	35,0			
1 1/4"	6280-114	47,5	20,5	43,5			
1 1/2"	6280-112	47,5	20,5	49,5			
2"	6280-200	57,0	25,0	62,0			
2 1/2"	6280-212	61,0	27,0	77,5			
3"	6280-300*	67,5	30,0	90,5			
4"	6280-400*	80,0	36,0	117,0			

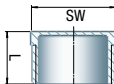

Kantenausführungen:
1/8" - 1/2": Sechskant
3/4" - 2": Achtkant
2 1/2" - 4": Zehnkant

290		SECHSKANTSTOPFEN			MAT. 1.4408		
GRÖSSE	ARTIKEL-NR.	ABMESSUNGEN [MM]					
		L	SW				
1/8"	6290-018	12,0	11,0				
1/4"	6290-014	14,5	15,0				
3/8"	6290-038	16,0	18,0				
1/2"	6290-012	19,5	22,0				
3/4"	6290-034	21,0	28,0				
1"	6290-100	24,0	35,0				
1 1/4"	6290-114	27,0	43,5				
1 1/2"	6290-112	27,0	49,5				
2"	6290-200	32,0	62,0				
2 1/2"	6290-212	34,0	77,5				
3"	6290-300	37,5	90,5				
4"	6290-400	44,0	117,0				

291		VIERKANT-STOPFEN, OHNE RAND				MAT. 1.4408	
GRÖSSE	ARTIKEL-NR.	ABMESSUNGEN [MM]					
		L	SW				
1/8"	6291-018	11,0	6,0				
1/4"	6291-014	13,5	7,0				
3/8"	6291-038	15,0	8,0				
1/2"	6291-012	18,5	10,0				
3/4"	6291-034	21,0	12,0				
1"	6291-100	25,5	14,0				
1 1/4"	6291-114	28,8	16,0				
1 1/2"	6291-112	29,0	20,0				
2"	6291-200	34,5	22,0				
2 1/2"	6291-212	38,5	28,0				
3"	6291-300	41,5	32,0				
4"	6291-400	51,5	40,0				

300		KAPPE, SECHSKANT				MAT. 1.4408	
GRÖSSE	ARTIKEL-NR.	ABMESSUNGEN [MM]					
		L	SW				
1/8"	6300-018	12,5	13,5				
1/4"	6300-014	16,0	17,0				
3/8"	6300-038	16,5	20,5				
1/2"	6300-012	21,0	25,0				
3/4"	6300-034	22,5	31,0				
1"	6300-100	26,0	38,0				
1 1/4"	6300-114	29,0	47,0				
1 1/2"	6300-112	29,0	53,0				
2"	6300-200	33,5	66,0				
2 1/2"	6300-212*	38,5	82,0				
3"	6300-300*	42,0	95,5				
4"	6300-400*	48,5	121,5				

310		GEGENMUTTER				MAT. 1.4408	
GRÖSSE	ARTIKEL-NR.	ABMESSUNGEN [MM]					
		L	SW				
1/8"	6310-018	5,0	15,0				
1/4"	6310-014	6,0	18,0				
3/8"	6310-038	6,0	22,0				
1/2"	6310-012	7,0	27,0				
3/4"	6310-034	7,0	32,0				
1"	6310-100	9,0	40,0				
1 1/4"	6310-114	11,0	48,0				
1 1/2"	6310-112	11,0	55,0				
2"	6310-200	13,0	68,0				
2 1/2"	6310-212	15,0	85,0				
3"	6310-300	17,0	100,0				
4"	6310-400	20,0	125,0				

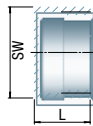
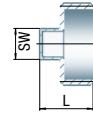

Art.-Nr. mit * in Ausführung Zehnkant

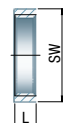



Art.-Nr. mit * in Ausführung Achtkant

GRÖSSE [1 X 2]	ARTIKEL-NR.	ABMESSUNGEN [MM]				
		L	L1	D1	d2	SW
1/8" x 7 mm	6315-1807	33,0	19,0	3,2	7,0	11,0
1/4" x 9 mm	6315-1409	42,5	28,0	5,0	9,0	15,0
3/8" x 11 mm	6315-3811	49,0	33,0	7,0	11,0	18,0
1/2" x 13 mm	6315-1213	59,5	38,0	8,0	13,0	22,0
3/4" x 20 mm	6315-3420*	66,0	45,0	15,0	20,0	28,0
1" x 25 mm	6315-1025*	75,0	48,0	20,0	25,0	36,0
1 1/4" x 33 mm	6315-11433*	79,0	52,0	27,5	33,0	43,5
1 1/2" x 40 mm	6315-11240*	83,0	56,0	34,0	40,0	49,5
2" x 52 mm	6315-2052	92,0	60,0	45,0	52,0	62,0
2 1/2" x 63,5 mm	6315-212635*	100,0	62,5	56,0	63,5	77,5
3" x 76,5 mm	6315-30765*	110,0	70,0	67,0	76,5	90,5
4" x 100 mm	6315-40100*	120,0	73,0	90,0	100,0	117,0

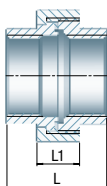

GRÖSSE	ARTIKEL-NR.	ABMESSUNGEN [MM]			
		L	L1	SW	
1/8"	6330-018	30,0	13,0	22	
1/4"	6330-014	33,5	13,5	27	
3/8"	6330-038	36,5	15,0	30	
1/2"	6330-012	39,5	16,0	36	
3/4"	6330-034	42,5	17,0	43	
1"	6330-100	50,0	20,0	51	
1 1/4"	6330-114	54,0	22,0	61	
1 1/2"	6330-112	58,0	24,0	69	
2"	6330-200	65,0	27,0	83	
2 1/2"	6330-212	75,0	29,5	104	
3"	6330-300	83,0	31,0	120,5	
4"	6330-400	110,0	34,0	147	

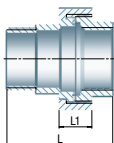

GRÖSSE	ARTIKEL-NR.	ABMESSUNGEN [MM]			
		L	L1	SW	
1/8"	6331-018	38,0	13,0	22	
1/4"	6331-014	44,0	13,5	27	
3/8"	6331-038	47,5	15,0	30	
1/2"	6331-012	54,0	16,0	36	
3/4"	6331-034	58,0	17,0	43	
1"	6331-100	68,0	20,0	51	
1 1/4"	6331-114	74,5	22,0	61	
1 1/2"	6331-112	78,5	24,0	69	
2"	6331-200	90,0	27,0	83	
2 1/2"	6331-212	102,0	29,5	104	
3"	6331-300	113,0	31,0	120,5	

332		VERSCHRAUBUNG SCHWEIBEINDE/ SCHWEIBEINDE, FLACH DICHTEND					MAT. 1.4408
GRÖSSE	ARTIKEL-NR.	ABMESSUNGEN [MM]					
		L	L1	D1	d2	SW	
1/4"	6332-014	33,5	13,5	13,5	8,8	27	
3/8"	6332-038	36,5	15,0	17,2	12,5	30	
1/2"	6332-012	39,5	16,0	21,3	16,0	36	
3/4"	6332-034	42,5	17,0	26,9	21,6	43	
1"	6332-100	50,0	20,0	33,7	27,2	51	
1 1/4"	6332-114	54,0	22,0	42,4	35,9	61	
1 1/2"	6332-112	58,0	24,0	48,3	41,8	69	
2"	6332-200	65,0	27,0	60,3	53,0	83	
2 1/2"	6332-212	75,0	29,5	76,1	68,8	104	
3"	6332-300	83,0	31,0	88,9	80,8	105	

333		VERSCHRAUBUNG A-GEW./ SCHWEIBEINDE, FLACH DICHTEND					MAT. 1.4408
GRÖSSE	ARTIKEL-NR.	ABMESSUNGEN [MM]					
		L	L1	D1	d2	SW	
1/4"	6333-014	45,0	13,5	13,5	8,8	27	
3/8"	6333-038	48,8	15,0	17,2	12,5	30	
1/2"	6333-012	56,3	16,0	21,3	16,0	36	
3/4"	6333-034	59,3	17,0	26,9	21,6	43	
1"	6333-100	69,0	20,0	33,7	27,2	51	
1 1/4"	6333-114	74,5	22,0	42,4	35,9	61	
1 1/2"	6333-112	78,0	24,0	48,3	41,8	69	
2"	6333-200	96,0	27,0	60,3	53,0	83	
2 1/2"	6333-212	99,3	29,5	76,1	68,8	104	

334		VERSCHRAUBUNG I-GEW./ SCHWEIBEINDE, FLACH DICHTEND					MAT. 1.4408
GRÖSSE	ARTIKEL-NR.	ABMESSUNGEN [MM]					
		L	L1	D1	d2	SW	
1/4"	6334-014	34,5	13,5	13,5	8,8	27	
3/8"	6334-038	37,8	15,0	17,2	12,5	30	
1/2"	6334-012	41,8	16,0	21,3	16,0	36	
3/4"	6334-034	43,8	17,0	26,9	21,6	43	
1"	6334-100	51,0	20,0	33,7	27,2	51	
1 1/4"	6334-114	54,0	22,0	42,4	35,9	61	
1 1/2"	6334-112	57,5	24,0	48,3	41,8	69	
2"	6334-200	71,0	27,0	60,3	53,0	83	

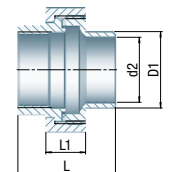
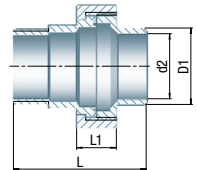
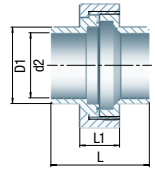

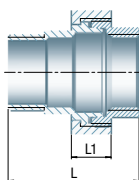
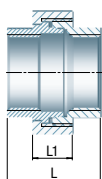
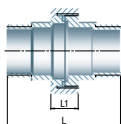

335		VERSCHRAUBUNG, A/A, FLACH DICHTEND				MAT. 1.4408	
GRÖSSE	ARTIKEL-NR.	ABMESSUNGEN [MM]					
		L	L1	SW			
1/2"	6335-012	68,5	16,0	36			
3/4"	6335-034	73,5	17,0	43			
1"	6335-100	86,0	20,0	51			
1 1/4"	6335-114	95,0	22,0	61			
1 1/2"	6335-112	99,0	24,0	69			

340		VERSCHRAUBUNG, I/I, KONISCH DICHTEND				MAT. 1.4408	
GRÖSSE	ARTIKEL-NR.	ABMESSUNGEN [MM]					
		L	L1	SW			
1/8"	6340-018	30,0	13,0	22			
1/4"	6340-014	33,5	13,5	27			
3/8"	6340-038	36,5	15,0	30			
1/2"	6340-012	39,5	16,0	36			
3/4"	6340-034	42,5	17,0	43			
1"	6340-100	50,0	20,0	51			
1 1/4"	6340-114	54,0	22,0	61			
1 1/2"	6340-112	58,0	24,0	69			
2"	6340-200	65,0	27,0	83			
2 1/2"	6340-212	75,0	29,5	104			
3"	6340-300	83,0	31,0	120,5			
4"	6340-400	110,0	34,0	147			

341		VERSCHRAUBUNG, A/I, KONISCH DICHTEND				MAT. 1.4408	
GRÖSSE	ARTIKEL-NR.	ABMESSUNGEN [MM]					
		L	L1	SW			
1/8"	6341-018	38,0	13,0	22			
1/4"	6341-014	44,0	13,5	27			
3/8"	6341-038	47,5	15,0	30			
1/2"	6341-012	54,0	16,0	36			
3/4"	6341-034	58,0	17,0	43			
1"	6341-100	68,0	20,0	51			
1 1/4"	6341-114	74,5	22,0	61			
1 1/2"	6341-112	78,5	24,0	69			
2"	6341-200	90,0	27,0	83			
2 1/2"	6341-212	102,0	29,5	104			
3"	6341-300	113,0	31,0	120,5			

342		VERSCHRAUBUNG, SCHWEIBENDE SCHWEIBENDE, KONISCH DICHTEND		MAT. 1.4408			
GRÖSSE	ARTIKEL-NR	ABMESSUNGEN [MM]					
		L	L1	D1	d2	SW	
1/4"	6342-014	35,5	13,5	13,5	8,8	27	
3/8"	6342-038	38,0	15,0	17,2	12,5	30	
1/2"	6342-012	44,0	16,0	21,3	16,0	36	
3/4"	6342-034	45,0	17,0	26,9	21,6	43	
1"	6342-100	50,0	20,0	33,7	27,2	51	
1 1/4"	6342-114	55,0	22,0	42,4	35,9	61	
1 1/2"	6342-112	57,0	24,0	48,3	41,8	69	
2"	6342-200	65,0	27,0	60,3	53,0	83	
2 1/2"	6342-212	71,0	29,5	76,1	68,8	104	
3"	6342-300	80,0	31,0	88,9	80,8	105	

343		VERSCHRAUBUNG, A-GEW./ SCHWEIBENDE, KONISCH DICHTEND		MAT. 1.4408			
GRÖSSE	ARTIKEL-NR	ABMESSUNGEN [MM]					
		L	L1	D1	d2	SW	
1/4"	6343-014	45,0	13,5	13,5	8,8	27	
3/8"	6343-038	48,8	15,0	17,2	12,5	30	
1/2"	6343-012	56,3	16,0	21,3	16,0	36	
3/4"	6343-034	59,3	17,0	26,9	21,6	43	
1"	6343-100	69,0	20,0	33,7	27,2	51	
1 1/4"	6343-114	74,5	22,0	42,4	35,9	61	
1 1/2"	6343-112	78,0	24,0	48,3	41,8	69	
2"	6343-200	96,0	27,0	60,3	53,0	83	

344		VERSCHRAUBUNG, I-GEW./ SCHWEIBENDE, KONISCH DICHTEND		MAT. 1.4408			
GRÖSSE	ARTIKEL-NR	ABMESSUNGEN [MM]					
		L	L1	D1	d2	SW	
1/4"	6344-014	34,5	13,5	13,5	8,8	27	
3/8"	6344-038	37,8	15,0	17,2	12,5	30	
1/2"	6344-012	41,8	16,0	21,3	16,0	36	
3/4"	6344-034	43,8	17,0	26,9	21,6	43	
1"	6344-100	51,0	20,0	33,7	27,2	51	
1 1/4"	6344-114	54,0	22,0	42,4	35,9	61	
1 1/2"	6344-112	57,5	24,0	48,3	41,8	69	
2"	6344-200	71,0	27,0	60,3	53,0	83	

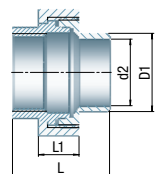
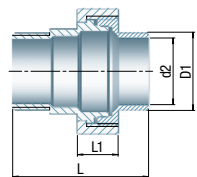
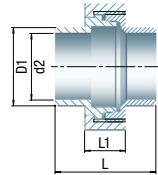

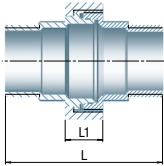

345		VERSCHRAUBUNG, A/A, KONISCH DICHTEND MAT. 1.4408				
GRÖSSE	ARTIKEL-NR	ABMESSUNGEN [MM]				
		L	L1	SW		
1/2"	6345-012	68,5	16,0	36		
3/4"	6345-034	73,5	17,0	43		
1"	6345-100	86,0	20,0	51		
2"	6345-200	115,0	27,0	83		

PTFE-Dichtungen, unterschiedliche Ausführungen auf Anfrage.



HIER ERFAHREN SIE MEHR



TYP 603

EINTEILIGER KUGELHAHN 1/4"-2"

- Reduzierter Durchgang mit Innengewinde und Schließlasche
- Ausblassichere Spindel
- Feinguss Gehäuse
- max. Druckstufe PN 63

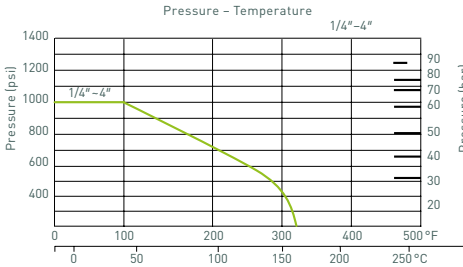

603

EINTEILIGER KUGELHAHN, REDUZIERTER DURCHGANG MIT INNENGEWINDE UND SCHLIESSLASCHE

MAT. 1.4408

GRÖSSE	ARTIKEL-NR.	ABMESSUNGEN [MM]						KG
		d	L	L1	H	W	S	
1/4"	603-014	5,0	39,0	19,0	30,0	70,0	17,0	0,060
3/8"	603-038	6,8	44,0	21,0	34,0	90,0	21,0	0,100
1/2"	603-012	9,2	56,5	27,5	41,0	100,0	25,0	0,175
3/4"	603-034	12,5	59,0	29,0	44,0	100,0	32,0	0,240
1"	603-100	15,0	71,0	34,5	50,0	110,0	38,0	0,390
1 1/4"	603-114	20,0	78,0	37,0	55,0	110,0	48,0	0,610
1 1/2"	603-112	25,0	83,0	40,0	64,0	135,0	53,0	0,760
2"	603-200	32,0	100,0	49,0	70,0	145,0	65,0	1,175

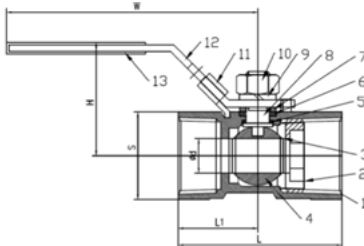
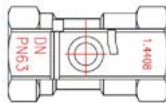

Nº	TEILE	ANZAHL	MATERIAL
1	Gehäuse	1	ASTM - A351 - CF8M
2	Kugelverschluss	1	ASTM - A351 - CF8M
3	Kugeldichtung	2	PTFE
4	Kugel	1	ASTM - A351 - CF8M
5	Unterlegscheibe	1	PTFE
6	Spindeldichtung	1	PTFE
7	Spindelscheibe	1	AISI 304
8	Spindel	1	AISI 316
9	Federscheibe	1	AISI 304
10	Spindelbuchse	1	AISI 304
11	Schließlasche	1	AISI 304
12	Griff	1	AISI 304
13	Kunststoffabdeckung	1	Plastik

TYP 604

ZWEITEILIGER KUGELHAHN 1/4" - 3"

- Voller Durchgang, Baulänge DIN 3202 M3, mit Innengewinde und Schlieflasche
- Ausblassichere Spindel
- Feinguss Gehäuse
- max. Druckstufe PN 63

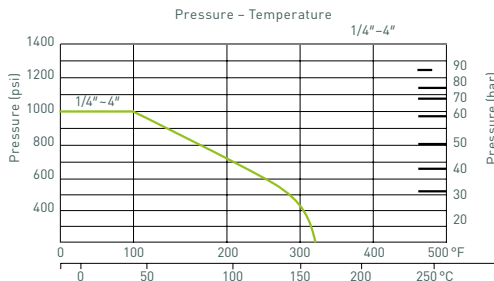

604

ZWEITEILIGER KUGELHAHN, VOLLER DURCHGANG, BAULÄNGE DIN 3202 M3, MIT INNENGEWINDE UND SCHLIESSLASCHE

MAT. 1.4408

GRÖSSE	ARTIKEL-NR.	ABMESSUNGEN [MM]				KG
		d	L	H	W	
1/4"	604-014	11,6	55,0	51,0	95,0	0,220
3/8"	604-038	12,7	60,0	51,0	95,0	0,200
1/2"	604-012	15,0	75,0	53,0	95,0	0,300
3/4"	604-034	20,0	80,0	59,0	110,0	0,460
1"	604-100	25,0	90,0	73,0	135,0	0,720
1 1/4"	604-114	32,0	110,0	78,0	135,0	1,180
1 1/2"	604-112	38,0	120,0	91,0	147,0	1,820
2"	604-200	50,0	140,0	99,0	165,0	2,820
2 1/2"	604-212	65,0	185,0	130,0	215,0	5,580
3"	604-300	80,0	205,0	142,0	215,0	9,240

N°	TEILE	ANZAHL	MATERIAL
1	Gehäuse	1	ASTM-CFM8-A351
2	Abdeckung	1	ASTM-CFM8-A351
3	Kugel	1	ASTM-CFM8-A351
4	Spindel	1	AISI 316
5	Kugeldichtung	2	PTFE
6	Unterlegscheibe	1	PTFE
7	Buchse	1	AISI 304
8	Spindeldichtung	2	PTFE
9	Dichtung	1	PTFE
10	Griff	1	AISI 304
11	Spindelscheibe	1	AISI 304
12	Spindelbuchse	1	AISI 304
13	Kunststoffabdeckung	1	PLASTIK

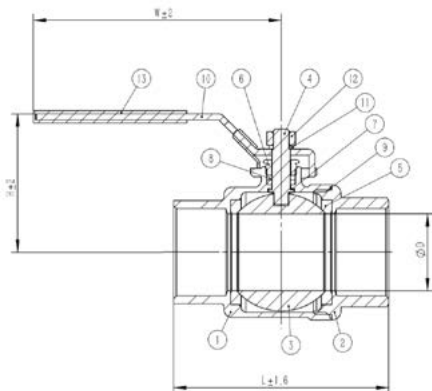

TYP 605

ZWEITEILIGER ECO-KUGELHAHN 1/4" - 4"

- Voller Durchgang mit Innengewinde und Schlieflasche
- Ausblassichere Spindel
- Feinguss Gehäuse
- max. Druckstufe PN 63

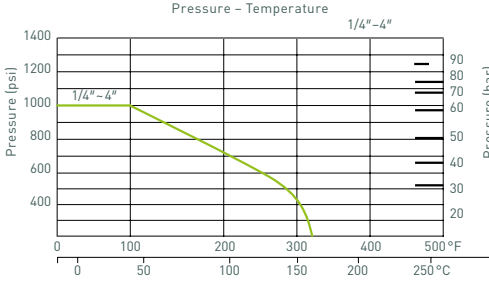

605

ZWEITEILIGER ECO-KUGELHAHN,
VOLLER DURCHGANG MIT INNENGEWINDE

MAT. 1.4408

GRÖSSE	ARTIKEL-NR.	ABMESSUNGEN [MM]				KG
		L	D	H	W	
1/4"	605-014	49,0	11,6	48,0	95,0	0,220
3/8"	605-038	49,0	12,7	48,0	95,0	0,200
1/2"	605-012	57,0	15,0	48,5	95,0	0,208
3/4"	605-034	65,0	20,0	54,5	108,0	0,319
1"	605-100	77,0	25,0	58,0	108,0	0,490
1 1/4"	605-114	90,0	32,0	70,5	130,0	0,792
1 1/2"	605-112	98,0	38,0	76,0	130,0	1,500
2"	605-200	121,0	50,0	83,5	165,0	2,057
2 1/2"	605-212	145,0	65,0	125,0	215,0	4,280
3"	605-300	166,0	80,0	136,0	215,0	6,400
4"	605-400	198,0	100,0	165,0	270,0	16,200

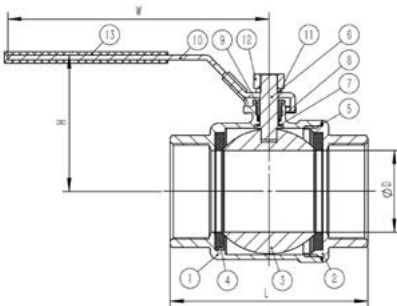

Nº	TEILE	ANZAHL	MATERIAL CF8M
1	Gehäuse	1	ASTM - A351 - CF8M
2	Abdeckung	1	ASTM - A351 - CF8M
3	Kugel	1	ASTM - A351 - CF8M
4	Kugeldichtung	2	PTFE
5	Dichtung	1	PTFE
6	Spindel	1	AISI 316
7	Unterlegscheibe	1	PTFE
8	Spindeldichtung	1	PTFE
9	Buchse	1	AISI 304
10	Griff	1	AISI 304
11	Spindelscheibe	1	AISI 304
12	Spindelscheibe	1	AISI 304
13	Kunststoffabdeckung	1	PLASTIK

TYP 607

DREITEILIGER KUGELHAHN 1/4"-4"

- Voller Durchgang mit Anschweißenden und Schließflasche
- Ausblässichere Spindel
- Feinguss Gehäuse
- max. Druckstufe PN 63

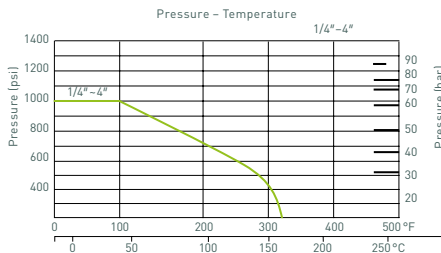

607 **DREITEILIGER KUGELHAHN, VOLLER DURCHGANG MIT ANSCHWEIßENDEN UND SCHLIESLASCHE** **MAT. 1.4408**

GRÖSSE	ARTIKEL-NR.	ABMESSUNGEN [MM]						KG	
ISO TOP									
		d	L	H	W	B	D		
1/4"	(13,5)	607-014	11,6	59,0	51,0	95,0	12,0	18,0	0,320
3/8"	(17,2)	607-038	12,7	59,0	51,0	95,0	14,0	18,0	0,330
DIN 3202 M3									
1/2"	(21,3)	607-012	15,0	75,0	55,0	95,0	15,5	21,3	0,449
3/4"	(26,9)	607-034	20,0	80,0	59,0	110,0	21,1	26,9	0,635
1"	(33,7)	607-100	25,0	90,0	73,0	135,0	27,3	33,7	0,910
1 1/4"	(42,4)	607-114	32,0	110,0	78,0	135,0	35,2	42,4	1,505
1 1/2"	(48,3)	607-112	38,0	120,0	91,0	147,0	41,1	48,3	2,065
2"	(60,3)	607-200	50,0	140,0	99,0	165,0	52,3	60,3	3,150
2 1/2"	(76,1)	607-212	65,0	185,0	130,0	215,0	65,0	76,1	6,685
3"	(88,9)	607-300	80,0	205,0	142,0	215,0	80,0	88,9	9,790
4"	(114,3)	607-400	100,0	240,0	174,0	310,0	102,0	115,0	20,320

ISO TOP*

N°	TEILE	ANZ.	MATERIAL
1	Schraube	4-6	AISI 304
2	Kugeldichtung	2	PTFE
3	Gehäuse	1	ASTM - A351 - CF8M
4	Kugel	1	ASTM - A351 - CF8M
5	Dichtung	2	PTFE
6	Abdeckung	2	ASTM - A351 - CF8M
7	Federscheibe	4-6	AISI 304
8	Sechskantschraube	4-6	AISI 304
9	Unterlegscheibe	1	PTFE
10	Spindel	1	AISI 316
11	Spindeldichtung	1	PTFE
12	Buchse	1	AISI 304
13	Griff	1	AISI 304
14	Spindelscheibe	1	AISI 304
15	Spindelbuchse	1	AISI 304
16	Schließflasche	1	AISI 304
17	Kunststoffabdeckung	1	PLASTIK

Technische Zeichnung für Artikel DIN3202 M3

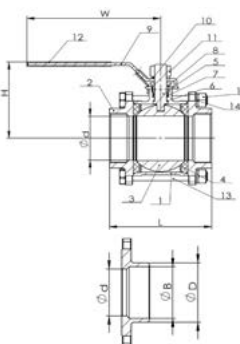

DIN3202 M3

N°	TEILE	ANZ.	MATERIAL
1	Gehäuse	1	ASTM - A351 - CF8M
2	Abdeckung	2	ASTM - A351 - CF8M
3	Kugel	1	ASTM - A351 - CF8M
4	Kugeldichtung	2	PTFE
5	Spindel	1	AISI 316
6	Unterlegscheibe	1	PTFE
7	Spindeldichtung	2	PTFE
8	Buchse	1	AISI 304
9	Griff	1	AISI 304
10	Spindelscheibe	1	AISI 304
11	Spindelbuchse	1	AISI 304
12	Kunststoffabdeckung	1	PLASTIK
13	Schraube	6	AISI 304
14	Federscheibe	6	AISI 304
15	Sechskantschraube	6	AISI 304

*Für die technische Zeichnung dieser Produkte fragen Sie unsere Büros.

TYP 608

DREITEILIGER KUGELHAHN 1/4"-4"

- Voller Durchgang mit Innengewinde und Schließflasche
- Ausblässichere Spindel
- Feinguss Gehäuse
- max. Druckstufe PN 63

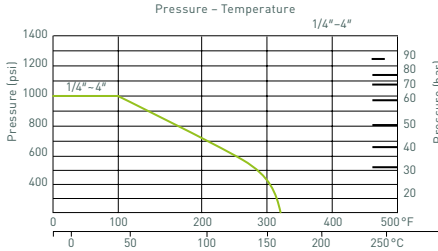

608

DREITEILIGER KUGELHAHN, VOLLER DURCHGANG MIT INNENGEWINDE UND SCHLISSLASCH

MAT. 1.4408

GRÖSSE	ARTIKEL-NR.	ABMESSUNGEN [MM]				KG
ISO TOP		d	L	H	W	
1/4"	608-014	11,6	59,0	51,0	95,0	0,320
3/8"	608-038	12,7	59,0	51,0	95,0	0,330
DIN 3202 M3						
1/2"	608-012	15,0	75,0	55,0	95,0	0,474
3/4"	608-034	20,0	80,0	59,0	110,0	0,651
1"	608-100	25,0	90,0	73,0	135,0	0,911
1 1/4"	608-114	32,0	110,0	78,0	135,0	1,466
1 1/2"	608-112	38,0	120,0	91,0	147,0	2,073
2"	608-200	50,0	140,0	99,0	165,0	3,492
2 1/2"	608-212	65,0	185,0	130,0	215,0	6,564
3"	608-300	80,0	205,0	142,0	215,0	10,480
4"	608-400	100,0	240,0	174,0	310,0	20,470

DIN3202 M3

Nº.	TEILE	ANZ	MATERIAL
1	Gehäuse	1	ASTM - A351 - CF8M
2	Abdeckung	2	ASTM - A351 - CF8M
3	Kugel	1	ASTM - A351 - CF8M
4	Kugeldichtung	2	PTFE
5	Spindel	1	AISI 316
6	Unterlegscheibe	1	PTFE
7	Spindeldichtung	2	PTFE
8	Buchse	1	AISI 304
9	Griff	1	AISI 304
10	Spindelscheibe	1	AISI 304
11	Spindelbuchse	1	AISI 304
12	Kunststoffabdeckung	1	PLASTIK
13	Schraube	6	AISI 304
14	Federscheibe	6	AISI 304
15	Sechskantschraube	6	AISI 304

Technische Zeichnung für Artikel DIN3202 M3

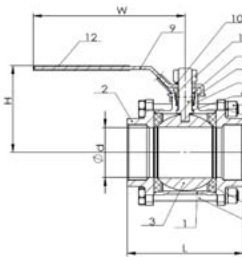

ISO TOP*

Nº.	TEILE	ANZ.	MATERIAL
1	Schraube	4-6	AISI 304
2	Kugeldichtung	2	PTFE
3	Gehäuse	1	ASTM - A351 - CF8M
4	Kugel	1	ASTM - A351 - CF8M
5	Dichtung	2	PTFE
6	Abdeckung	2	ASTM - A351 - CF8M
7	Federscheibe	4-6	AISI 304
8	Sechskantschraube	4-6	AISI 304
9	Unterlegscheibe	1	PTFE
10	Spindel	1	AISI 316
11	Spindeldichtung	1	PTFE
12	Buchse	1	AISI 304
13	Griff	1	AISI 304
14	Spindelscheibe	1	AISI 304
15	Spindelbuchse	1	AISI 304
16	Schließflasche	1	AISI 304
17	Kunststoffabdeckung	1	PLASTIK

*Für die technische Zeichnung dieser Produkte fragen Sie unsere Büros.

NEW

TYPE 610

1/2"-2" SCHMUTZFÄNGER AUS EDELSTAHL

- Schmutzfänger mit Innengewinde DIN EN 10226-1 / ISO 7-1
- Form: Schrägsitz
- Medien: Warm- und Kaltwasser
- Betriebstemperatur: -20°C - + 180°C
- Betriebsdruck: max. 40 bar
- Filtersieb MW 1 mm
- Siebeinsatz mit Dichtung als Ersatzteil erhältlich



610		SCHMUTZFÄNGER MIT INNENGEWINDE					
GRÖSSE	ARTIKEL.-NR.	ABMESSUNGEN [MM]					
		A	L	D	W	H	kg/Stck.
1/2"	610-012	15	65	1	2	39	0,225
3/4"	610-034	20	80	1	2	45	0,322
1"	610-100	25	90	1	2	52	0,540
1 1/4"	610-114	32	105	1	2	58	0,723
1 1/2"	610-112	40	120	1	2	72	1,020
2"	610-200	50	140	1	2	80	1,426

**ERSATZTEILSET DICHTUNG + FILTERSIEB
(AUSSCHLIESSLICH FÜR ARTIKEL 610-012 BIS 610-200)**

GRÖSSE SCHMUTZFÄNGER	ARTIKEL.-NR.
1/2"	610-012E
3/4"	610-034E
1"	610-100E
1 1/4"	610-114E
1 1/2"	610-112E
2"	610-200E

Nr.	Teile	QTY	Material
1	Gehäuse	1	CF8 – CF8M
2	Kappe	1	CF8 – CF8M
3	Filter	1	AISI 316
4	Dichtung	1	PTFE

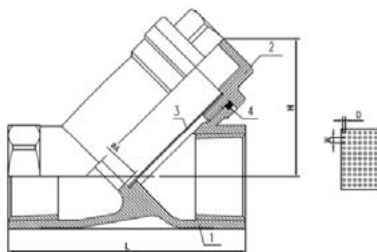

ROHRDOPPELNIPPEL MIT BEIDSEITIGEM GEWINDE

MAT. 1.4404

GEWINDEANSCHLUSS (R) X LÄNGE (L)	ROHR-AUSSEN-Ø (D) X WANDSTÄRKE (T)	ARTIKEL-NR.
1/8" x 40 mm	10,2 x 2,0 mm	6070.040.01
1/8" x 60 mm	10,2 x 2,0 mm	6070.060.01
1/8" x 100 mm	10,2 x 2,0 mm	6070.100.01
1/4" x 30 mm	13,5 x 2,3 mm	6070.030.02
1/4" x 40 mm	13,5 x 2,3 mm	6070.040.02
1/4" x 60 mm	13,5 x 2,3 mm	6070.060.02
1/4" x 80 mm	13,5 x 2,3 mm	6070.080.02
1/4" x 100 mm	13,5 x 2,3 mm	6070.100.02
1/4" x 120 mm	13,5 x 2,3 mm	6070.120.02
1/4" x 150 mm	13,5 x 2,3 mm	6070.150.02
1/4" x 200 mm	13,5 x 2,3 mm	6070.200.02
3/8" x 40 mm	17,2 x 2,3 mm	6070.040.03
3/8" x 60 mm	17,2 x 2,3 mm	6070.060.03
3/8" x 80 mm	17,2 x 2,3 mm	6070.080.03
3/8" x 100 mm	17,2 x 2,3 mm	6070.100.03
3/8" x 120 mm	17,2 x 2,3 mm	6070.120.03
3/8" x 150 mm	17,2 x 2,3 mm	6070.150.03
3/8" x 200 mm	17,2 x 2,3 mm	6070.200.03
1/2" x 40 mm	21,3 x 2,6 mm	6070.040.04
1/2" x 60 mm	21,3 x 2,6 mm	6070.060.04
1/2" x 80 mm	21,3 x 2,6 mm	6070.080.04
1/2" x 100 mm	21,3 x 2,6 mm	6070.100.04
1/2" x 120 mm	21,3 x 2,6 mm	6070.120.04
1/2" x 150 mm	21,3 x 2,6 mm	6070.150.04
1/2" x 200 mm	21,3 x 2,6 mm	6070.200.04
1/2" x 300 mm	21,3 x 2,6 mm	6070.300.04
3/4" x 40 mm	26,9 x 2,6 mm	6070.040.05
3/4" x 60 mm	26,9 x 2,6 mm	6070.060.05
3/4" x 80 mm	26,9 x 2,6 mm	6070.080.05
3/4" x 100 mm	26,9 x 2,6 mm	6070.100.05
3/4" x 120 mm	26,9 x 2,6 mm	6070.120.05
3/4" x 150 mm	26,9 x 2,6 mm	6070.150.05
3/4" x 200 mm	26,9 x 2,6 mm	6070.200.05
3/4" x 300 mm	26,9 x 2,6 mm	6070.300.05
1" x 40 mm	33,7 x 3,2 mm	6070.040.06
1" x 60 mm	33,7 x 3,2 mm	6070.060.06
1" x 80 mm	33,7 x 3,2 mm	6070.080.06
1" x 100 mm	33,7 x 3,2 mm	6070.100.06
1" x 120 mm	33,7 x 3,2 mm	6070.120.06
1" x 150 mm	33,7 x 3,2 mm	6070.150.06
1" x 200 mm	33,7 x 3,2 mm	6070.200.06
1" x 300 mm	33,7 x 3,2 mm	6070.300.06

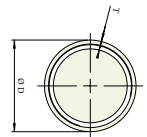
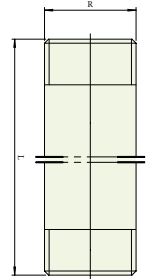

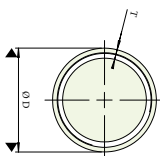
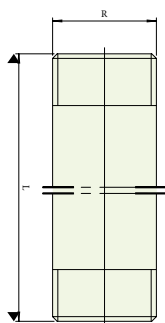

ROHRDOPPELNIPPEL MIT BEIDSEITIGEM GEWINDE

MAT. 1.4404

GEWINDEANSCHLUSS (R) X LÄNGE (L)	ROHR-AUSSEN-Ø (D) X WANDSTÄRKE (T)	ARTIKEL-NR.
1 1/4" x 40 mm	42,4 x 3,2 mm	6070.040.07
1 1/4" x 60 mm	42,4 x 3,2 mm	6070.060.07
1 1/4" x 80 mm	42,4 x 3,2 mm	6070.080.07
1 1/4" x 100 mm	42,4 x 3,2 mm	6070.100.07
1 1/4" x 120 mm	42,4 x 3,2 mm	6070.120.07
1 1/4" x 150 mm	42,4 x 3,2 mm	6070.150.07
1 1/4" x 200 mm	42,4 x 3,2 mm	6070.200.07
1 1/2" x 40 mm	48,3 x 3,2 mm	6070.040.08
1 1/2" x 60 mm	48,3 x 3,2 mm	6070.060.08
1 1/2" x 80 mm	48,3 x 3,2 mm	6070.080.08
1 1/2" x 100 mm	48,3 x 3,2 mm	6070.100.08
1 1/2" x 120 mm	48,3 x 3,2 mm	6070.120.08
1 1/2" x 150 mm	48,3 x 3,2 mm	6070.150.08
1 1/2" x 200 mm	48,3 x 3,2 mm	6070.200.08
2" x 40 mm	60,3 x 3,6 mm	6070.040.09
2" x 60 mm	60,3 x 3,6 mm	6070.060.09
2" x 80 mm	60,3 x 3,6 mm	6070.080.09
2" x 100 mm	60,3 x 3,6 mm	6070.100.09
2" x 120 mm	60,3 x 3,6 mm	6070.120.09
2" x 150 mm	60,3 x 3,6 mm	6070.150.09
2" x 200 mm	60,3 x 3,6 mm	6070.200.09
2 1/2" x 100 mm	76,1 x 3,6 mm	6070.100.10
2 1/2" x 120 mm	76,1 x 3,6 mm	6070.120.10
2 1/2" x 150 mm	76,1 x 3,6 mm	6070.150.10
3" x 120 mm	88,9 x 4,0 mm	6070.120.11
3" x 150 mm	88,9 x 4,0 mm	6070.150.11
3" x 200 mm	88,9 x 4,0 mm	6070.200.11
4" x 100 mm	114,3 x 4,5 mm	6070.100.12
4" x 120 mm	114,3 x 4,5 mm	6070.120.12

ANSCHWEISSNIPPEL MIT EINSEITIGEM GEWINDE

MAT. 1.4404

GEWINDEANSCHLUSS (R) X LÄNGE (L)	ROHR-AUSSEN-Ø (D) X WANDSTÄRKE (T)	ARTIKEL-NR.
1/8" x 30 mm	10,2 x 2,0 mm	6072.030.01
1/4" x 30 mm	13,5 x 2,3 mm	6072.030.02
3/8" x 30 mm	17,2 x 2,3 mm	6072.030.03
1/2" x 35 mm	21,3 x 2,6 mm	6072.035.04
3/4" x 40 mm	26,9 x 2,6 mm	6072.040.05
1" x 40 mm	33,7 x 3,2 mm	6072.040.06
1 1/4" x 50 mm	42,4 x 3,2 mm	6072.050.07
1 1/2" x 50 mm	48,3 x 3,2 mm	6072.050.08
2" x 50 mm	60,3 x 3,6 mm	6072.050.09
2 1/2" x 60 mm	76,1 x 3,6 mm	6072.060.10
3" x 70 mm	88,9 x 4,0 mm	6072.070.11
4" x 80 mm	114,3 x 4,5 mm	6072.080.12

